



Con.tradition / Sara Bernardi, 2013-2017

Lanterne luminose da sospensione con struttura in metallo lavorato, struttura cablata in finitura nichel nero. Lampadina da 60W con filamento in carbone inclusa. In quattro dimensioni.

Finiture: nero RAL 9005, cromo.

Lanterne à suspendre avec structure en métal travaillé, structure câblée en finition nickel noir. Ampoule 60W avec filamento en carbone incluse. Quatre tailles différentes.

Finitions: noir RAL 9005, chromé.

Luminous ceiling lanterns with structure in metal, wired structure in black nickel finish. 60W carbon-wire lightbulb included. Four dimensions.
Finishing: black RAL 9005, chrome.

Hängeleuchte lichtpendende Laternen aus Metall, Struktur für die Verkabelung aus schwarzem Nickel. Einschließlich 60W Kohlenfaden-Glühbirne. In vier Größen.
Ausführungen: schwarz RAL 9005, Chrom.



CE **IECEE**

Finiture / Finishing / Finitions / Ausführungen



Nero RAL 9005
Black RAL 9005
Noir RAL 9005
Schwarz RAL 9005



Cromo
Chrome
Chrom

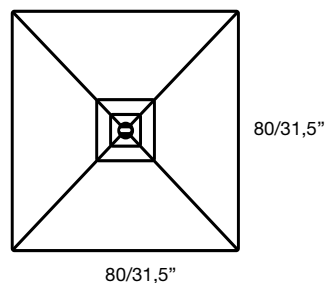
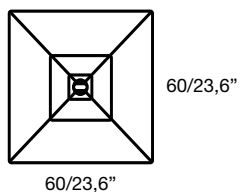
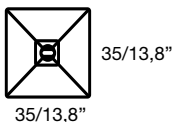
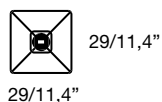
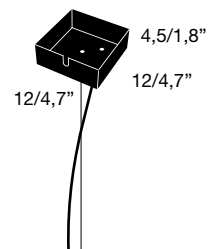
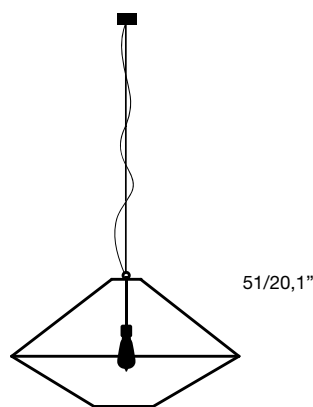
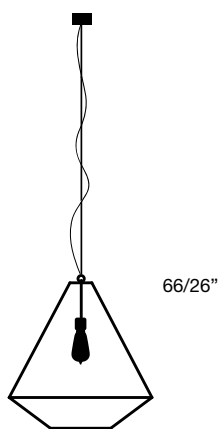
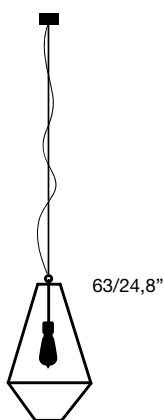
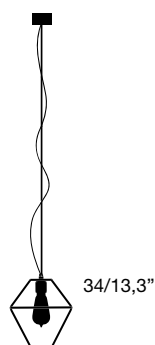

ceiling rose



lightbulb

XS

S

M

L



220V
HALOGEN / LED
MAX 1x60W E27

NOTE

n1 lampadina con Attacco E27 - inclusa.
n1 light bulb E27 - included.
n1 ampoule avec fixation E27 - inclus.
n1 Glühbirne mit Anschluss E27 - inklusive.

OPINION CIATTI®
FIRENZE

